

Data Sheet



Article number: 20301359

Description: E+G Handwheel
DIN 950-GG-500-B40-A

Measures

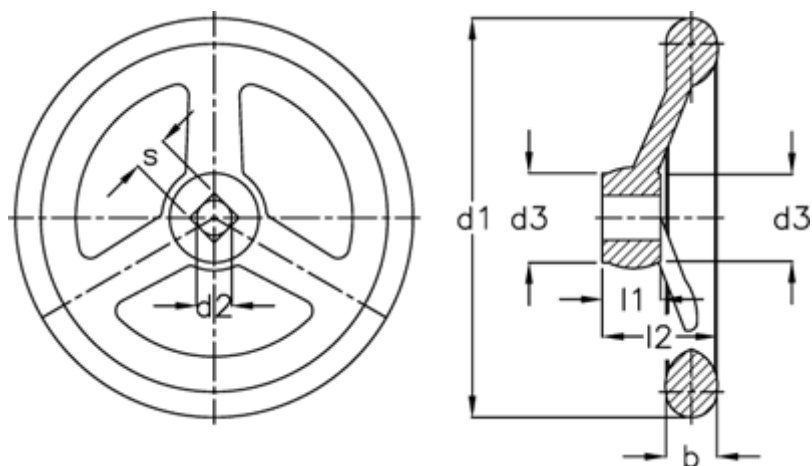

b	= 34
d1	= 500
d2 H7	= 40
d3	= 78
l1	= 45
l2	= 72
Number of spokes	= 5